

2012+ RAM 2500/3500 Hub Kit – Stage 1 4x4, Front Axle “Free Spin” Conversion Kit

Some uncommon tools, which will be required:

- 6-point Spanner socket (OTC #7090-A or equivalent) This can be purchased from Dynatrac or an auto parts store.
- 18mm, 12-point, ½” drive socket
- 1-11/16”, 6 point socket
- Calibrated torque wrench.
- Anti-Seize compound.
- High quality, disc brake wheel bearing grease.
- Bearing Race Punch (Snap-on #PPC14LA is a good one) to install bearing races.
- 4 quarts of high quality gear oil – OPTIONAL

ⓘ INFORMATION: Trucks with dual rear wheels will require the use of a special dually wheel adapter. These can be purchased through Arrowcraft. (248)-280-0210 Ask for part number AA4DDT as these parts have been made to work specifically with Dynatrac’s Free-Spin kit.

Preparation and Inspection Checks:

1. Read all instructions completely. Only perform this installation if you are an experienced, fully equipped mechanic. Inspect all boxes and packing material to expose all the parts in the kit. Using the bill of material attached, verify that the kit is complete. Contact Dynatrac about any shortages at (714) 596-4461. Do not start the installation until you are sure you have everything you need. Allow yourself plenty of time. You will need anywhere from 5 to 10 hours depending on your skill and experience level.

⚠ WARNING: Always wear proper safety equipment including safety glasses and gloves while working with tools. Improper use of tools and equipment can cause injury or death.

⚠ WARNING: Only perform this installation if you are an experienced, fully equipped mechanic.

2. You can reuse the original U-joints, but it is a good idea to replace the U-joints when installing this kit. We have designed it to work with your original parts. Use caution not to damage your U-joints when removing them from the outer axle shaft. If you do need a U-joint for this application (AAM axle), the joints are currently available only through your Dodge Dealer. So, check for availability before you take your truck apart.
3. This kit **MAY NOT be compatible** with Dual Rear Wheel (DRW) trucks.
Trucks equipped with the **DRW wheels WILL require a special DRW adapter.** These can be purchased through Arrowcraft. (248)-280-0210 Ask for part number AA4DDT as these parts have been made to work specifically with Dynatrac's Free-Spin kit.
Test fit the DRW front wheel adapter on the new hubs **BEFORE** installing the kit. If the adapter does not fit **STOP!! DO NOT weaken the adapter by removing material from the inside!** DO NOT remove material from the new Dynatrac wheel hub. At this point you may return the kit to the place of purchase for a full refund. Contact Dynatrac if you need assistance.

 **WARNING: Removing too much material from the inside of the Stock DRW front wheel adapter may weaken it, and cause the wheel to separate from the vehicle without warning. This may cause property damage, injury or even the death to your vehicle's occupants and those in vehicles around you. You may choose to stop now and return this kit for a full refund. Or you may replace the stock adapter with a suitable aftermarket part. Contact Dynatrac if you need assistance.**

 **INFORMATION: Replace old U-Joints if they are worn.**

 **WARNING: If tone rings are not installed on your hubs, the ABS system will not work.**

4. If your truck is ABS equipped, make sure the new hubs have tone rings mounted on the short side of the new hubs. **See Illustration 2.** If they have been shipped loose they should lightly press onto the back of the hub. Tapping them on with a soft face, dead blow hammer works fine.
5. Inspect the inside of the new wheel hubs for any leftover debris or dirt. Wash the inside thoroughly with rags and hot soapy water. If the bearing races are not already installed in the wheel hubs, use a race driver to install them at this time. Snap-on, 9/16 race driver, #PPC14LA works great.
6. Test fit the new inner and outer bearings onto each of the new spindles. The bearings will fit snug, but go on easily by hand. However, it is a very precise fit. If

they get cocked they will lock themselves into place. Tapping them lightly on the high side will straighten them out. Patience is essential.

7. Drive or press new wheel studs supplied with the kit into the new wheel hubs at this time. The new studs should go in very tight and be fully seated. The studs should not stick up above the counter bore in the hub flange. **See *Illustration 2*.**

 **WARNING: DO NOT pull the studs through with a lug nut, as this will risk your safety and the safety of those around you on the highway. Improperly installed studs can cause major failures that could lead to injury or death.**

8. Raise the front axle off the ground and secure with jack stands. Remove the wheels.

 **WARNING: Always use appropriate jack stands when raising your vehicle. Never work under a vehicle that is not properly secured. Be sure to chock any wheels that are on the ground.**

Begin Front Axle Teardown:

9. You may wish to remove the differential cover and drain the gear oil. It is common for oil to leak into the axle housing tubes when the inner axles are pulled outward past the inner axle seals. Whether you drain the oil or not, it is best to thoroughly clean the inside of the axle tubes from any dirt, rust or oil residue BEFORE re-installing the axle shafts later in the install process.
10. Using the 1-11/16" socket and a long breaker bar (or impact gun), remove the cotter pin and the big nut at the center of the stock live spindle assembly. The nut can be very tight. Have someone step on the brake pedal to keep the stock hub from rotating if needed.
11. Remove the calipers and hang them securely from the frame without disconnecting the brake hoses. Remove the rotors.
12. There are two (2) pilot diameters machined on the outer end (long side) of the new wheel hubs. The inner pilot (larger diameter) locates the rotor and the smaller outer pilot locates the wheel. Make sure that the rotor and the wheel fit easily but snugly around their respective pilot diameter.

 **INFORMATION: Trial fit all parts on both sides of the truck before assembly.**

13. **If truck is equipped with front ABS:** Remove the sensor and cable from the unit bearing. It is held in with only one (1) screw, and pulls straight out. Tie off and out of the way. At this time make certain that the hubs included in the kit have ABS tone

rings pressed on to the short side of the hub. If the hubs do not have the tone rings, contact Dynatrac immediately for replacements.

 **WARNING: If tone rings are not installed on your hubs, the ABS system will not work.**

 **CAUTION: Be careful not to damage the ABS sensor while removing it from the unit bearing.**

14. To remove the unit bearing assembly: Use ONLY a 18mm 12 point socket to remove the 4 bolts that hold the live spindle assembly to the knuckle. Other sockets may appear to fit, but may cause the bolt heads to become rounded off!! They are removed from the backside. Corrosion can make it very difficult to remove the unit bearing from the knuckle; a dead blow hammer and prybars work best when breaking loose the two components. Set aside unit bearing. Keep the four (4) bolts for installing the new spindle.

 **WARNING: Do not use high heat to remove the live spindle from the knuckle, this can cause damage to the components and reduce their strength.**

15. Remove the axle shaft assembly. It is only held in by tight seal tension at the differential. Use 1 or 2 pry bars between the yoke and the end of the axle housing to pull straight outward if necessary. Be careful not to damage your axle seals when removing the shafts. Set shafts aside.
16. Remove the stock outer shafts from the U-joints. The U-joint caps are matched to the U-joint so make sure that they are put back in the right locations. Install the new 35 spline outer shaft onto the U-joint. If the old joints are worn out, this is the best time to replace them.

 **INFORMATION: Replace old U-Joints if they appear worn.**

Begin Front Axle Reassembly:

17. Install the boot seals on the outer shafts. They should press onto the shoulder of the outer shaft with the force of your hands and a light tap with a soft hammer. Be careful not to damage the seal. **See *Illustration 1*.**
18. Clean out any debris or corrosion from the axle tube before moving any further. This will ensure the best performance from the seals and bearings.
19. Test fit your outer shafts fully into the needle bearing in the back of the spindle. A soft tap should fully seat the bearing. If it is tight, or does not rotate easily contact

Dynatrac for a replacement. Be careful not to damage the spindle seal with the splines when installing the shaft.

20. Lightly grease the seal surfaces on the inner shafts.
21. Carefully insert the shaft into the axle housing. Be careful not to get any dirt or other contamination on the shaft as you install it, as it could damage the bearings and seals. Guide the shaft up into the inner seal and differential gears. Use a rubber mallet to tap the end of the shaft inward until it stops. You may have to rotate the shaft to align the splines in the differential.
22. Generously pack the spindle needle bearing, the area around the thrust washer, and the outer shaft boot seal with a high quality wheel bearing grease. **See Illustration 3**
23. Install the brake splash shields for the front disc brakes between the spindle and the knuckle. Confirm they have the correct orientation, or the shield will prevent rotor installation.
24. Put a light coating of anti-seize compound on the shoulder surface of the spindle. The anti-seize will make any future servicing much easier. **See Illustration 3.** While guiding the outer shaft through the spindle, mount the spindle into the knuckle; be careful not to damage the seal in the back of the spindle. Position the ABS sensor block at the 12 o'clock position.
25. Secure the spindle to the knuckle using the four (4) factory spindle mounting bolts (M14 x 1.5 x 55mm) removed during the initial teardown. Apply Loc-tite 271 to the bolts. Tighten the bolts to 149 ft-lbs (202 Nm) in a criss-cross pattern. Make sure the spindle is firmly seated and there are no gaps between the knuckle, shield, or spindle.



WARNING: Use a calibrated torque wrench on all bolts. Always torque bolts in the order listed.

26. Check the shaft assembly for some endplay in and out. There MUST be at least some endplay. The grease may make it difficult to feel the end play, so you may want to pry the shaft in and out several times using screwdrivers at the U-joint until you are certain that end play is present. **DO NOT CONTINUE IF THERE IS NO END PLAY.**



WARNING: Do not continue if there is no endplay in the shaft assembly after installation. Contact Dynatrac for assistance.

27. Inspect the length of the lug nut vs. the length of the wheel stud. The studs supplied with the kit are longer than stock to accommodate thicker aluminum aftermarket wheels. If you have stock steel wheels, you may need to trim the stud to obtain the

proper fit. Failure to do so could result in a wheel that may be loose and could cause damage or injury.

28. Pack the new wheel bearings with grease. Proper packing of the bearings is essential to bearing life and safety. **Grease must thoroughly and completely fill the voids between each roller, especially underneath the roller cage.** Do not just smear grease around the outside. This can easily be accomplished by hand or with a simple bearing packer and grease gun available at any auto parts store. Load the inner bearing (large) into the new hub.

 **WARNING: Properly packing the wheel bearings is essential to bearing life. Failure to properly lubricate a bearing can result in bearing failure, damage to other components, and risk of serious injury or death.**

29. Prepare the large hub seal for installation by generously greasing all lips on the seal. **See Illustration 3.** This will prevent any damage to the sealing surfaces. Drive the hub seal into the back of the hub. The open side of the seal faces the inside of the hub.

30. **Liberal grease the area inside the hub between the bearings,** up to the inside diameter of the inner & outer bearings. Do not skimp on the grease, completely fill this area. There must be enough grease between the bearings so that centrifugal force does not pull grease away from the bearings into the center of the hub.

31. After fully packing with grease, install the new wheel hubs onto the spindles. Be careful not to damage the hub seal as it slides over the threaded end of the spindle. Push the hub onto the spindle until the inner bearing bottoms out. **If it gets stuck part way, stop!** Pull the hub off and try again, keeping the bearing straight as it slides onto the spindle. Push the outer bearing over the end of the spindle and into the open end of the hub. It must seat against the outer race in the wheel hub.

 **CAUTION: Be careful not to damage the hub seal when installing it over the threaded end of the spindle.**

 **WARNING: Do not use the spanner nuts to force the hub and bearings onto the spindle. If necessary, you may gently tap the outer edge of the hub with a rubber mallet.**

32. Screw the inner spanner nut onto the end of the spindle. Torque the inner nut to 50 ft.lbs while rotating the hub. Then back it off $\frac{1}{8}$ of a turn. Finish by making sure the inner spanner nut is hand tight. See page 1 for sourcing the proper hub socket. **DO NOT use punches to tap the nuts around!**

 **WARNING: Use the proper tools and procedure to install the spanner nuts or you may damage the bearings.**

33. Install the star shaped lock washer with the outer tabs pointing outward. Align the tab on the inside of the washer with the slot in the spindle. **Put a coat of grease on the back of the outer spanner nut.** Screw the outer spanner nut on the spindle and tighten to 70 ft-lbs. Then bend at least one of the tabs over the front of the outer nut into one of the six (6) points on the nut. The hub should spin freely with no pre-load on the bearings, but not have more than .001" of end play.
34. Install the WARN® locking hubs or Dynaloc™ locking hubs . The gear body just slides in, and is held in place by the big internal snap ring. Then the small snap ring goes over the end of the outer axle shaft. You may need to pry the axle shaft outward to expose the snap ring groove on the end of the shaft.
35. Allen screws hold on the cap (6 for WARN, 3 for DynaLoc). DO NOT over tighten the Allen screws. Further instructions are included with the locking hubs. Please refer to those directions for installing your hubs.
36. Check the hubs by locking and unlocking several times. Never use tools to turn the locking hub knobs; they should turn without the use of a tool. Rotate the wheel forward and backward while simultaneously turning the knob if you feel too much resistance.

 **CAUTION: Further instructions are included with the WARN® locking hubs; follow them for proper installation.**

 **CAUTION: Never use tools to turn the knob on the locking hub; it should turn without the use of a tool.**

37. **ABS Equipped Only:** Insert the ABS Sensor into the mounting block on the spindle. Use the stock screw to secure it. There should be an air gap between the tone ring and the tip of the sensor of at least .015" but less than .055". Secure the ABS sensor wiring as it was before you removed it from the original unit bearing so that it is clear of all moving components.

 **WARNING: Make sure that the ABS sensor has at least .015" clearance between the tip of the sensor and the tone ring. If the ABS sensor contacts the tone ring it can be damaged resulting in the ABS system to malfunction.**

38. Install the stock brake rotor over the outside of the wheel hub and hold it in place with two (2) lug nuts. Route the cable for the ABS sensor so it will NOT touch the

inside of the rotor during vehicle operation. Rotate the rotor 360° to make sure that there is no interference with any other components.

 **WARNING: Make sure that the ABS sensor cable is secure and clear of the rotor.**

39. Put the caliper back over the rotor and secure using your original caliper bolts with some Lock-tite 271. Torque the bolts to 275 ft lbs (373 Nm). Spin the rotor and make certain that the caliper has adequate clearance from the brake rotor.

 **WARNING: Reinstall the large bolts that hold the caliper to the ears on the knuckle. Check for adequate clearance between the brake rotor and the caliper.**

40. Install your wheels on the new hubs and tighten your lug nuts to 140 ft-lbs (190 Nm).
 - a. Trucks with dual rear wheels: Install your hub adapter as per instructions from Arrowcraft, and then install your wheels.

41. If any gear oil was lost during installation of your hub kit, refill the axle to the previously noted level and test drive.

 **WARNING: Failure to properly refill the axle with Gear Oil can cause serious gear and bearing failure which could result in serious injury or death.**

42. Recheck bolt torque on lug nuts after test-driving.

43. Verify the proper gear oil level after a test drive.

44. Check the torque on your lug nuts every 500 miles.

 **WARNING: Failure to check bolt and lugnut torque can cause serious accident, component failure, serious injury or death.**

Bill of Material

2012 RAM *Free Spin* Hub Kit Stage 1

CR60-3X1104-L (DynaLoc) or K (Warn)

<u>Description</u>	<u>Quantity</u>	<u>Dynatrac P/N</u>	<u>Manuf P/N</u>
Hub	2	CR60-1104-G	
Spindle	2	CR60-3105-H	
Spindle Bearing	2	DA60-3123-A	Spicer 620063
Thrust Washer & Seal Combo	2	DA60-1X1175-A	Spicer 44506
Boot Seal	2	DA60-1175-F	Spicer 50381
35 Spline Outer Shaft	2	CR60-3B387-B	
Inner Wheel Bearing	2	DA60-1244-A	387A
Inner Wheel Race	2	DA60-4222-B	382A
Outer Wheel Bearing	2	DA60-1244-B	LM104949
Outer Wheel Race	2	DA60-4222-C	LM104911
Hub Seal	2	DA60-1175-D	475960
Spindle Nut, 6 Point	4	DA60-1195-A	
Spindle Nut Washer	2	DA60-1198-A	
Wheel Studs - 14mm x 1.5	16	FO60-1107-C	
DynaLoc Locking Hub - 35 Spline	2	DT60-3B396-BD	
ABS - Tone Ring	2	DA60-2C189-B	
Mounting Block, ABS Sensor	2	CR60-2C188-A	
Bolt, 5/16-18 x .75", 12 Point HHCS	2	DA60-4346-B	

FOR BEARING AND SEAL SERVICE KITS ORDER:

DA60-1X1244-A Bearings and seals for the hub (Limited 4WD usage)

DA60-1X1244-E Bearings and seals for the hub and spindle (Heavy 4WD usage)

Illustration 1. Components

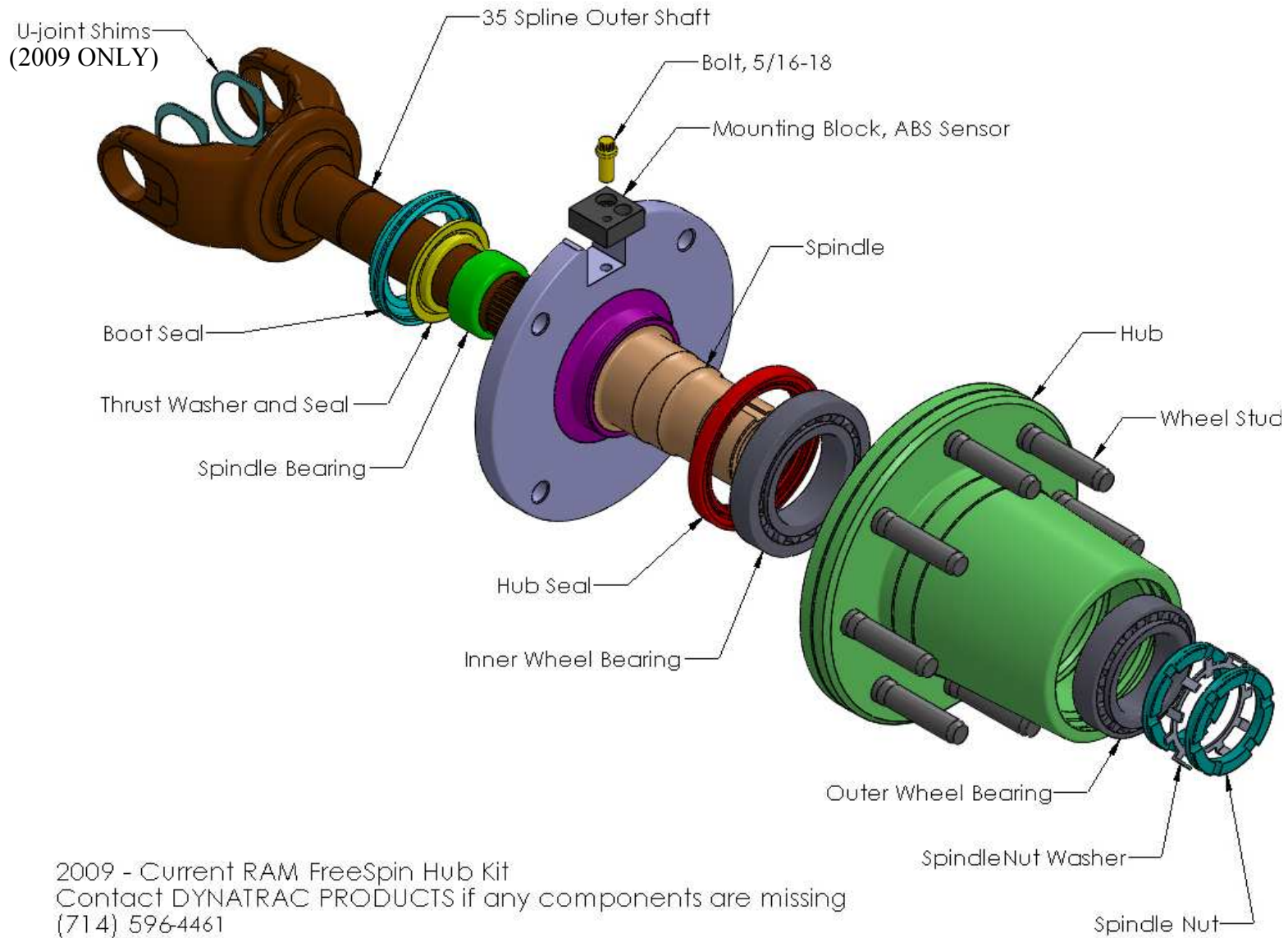

2009 - Current RAM FreeSpin Hub Kit
Contact DYNATRAC PRODUCTS if any components are missing
(714) 596-4461

Illustration 2. Hub Assembly

Hub Assembly

Wheel stud must be pressed in completely until it sits below the surface of the hub flange.
DO NOT USE A LUGNUT TO PULL THE STUD THROUGH

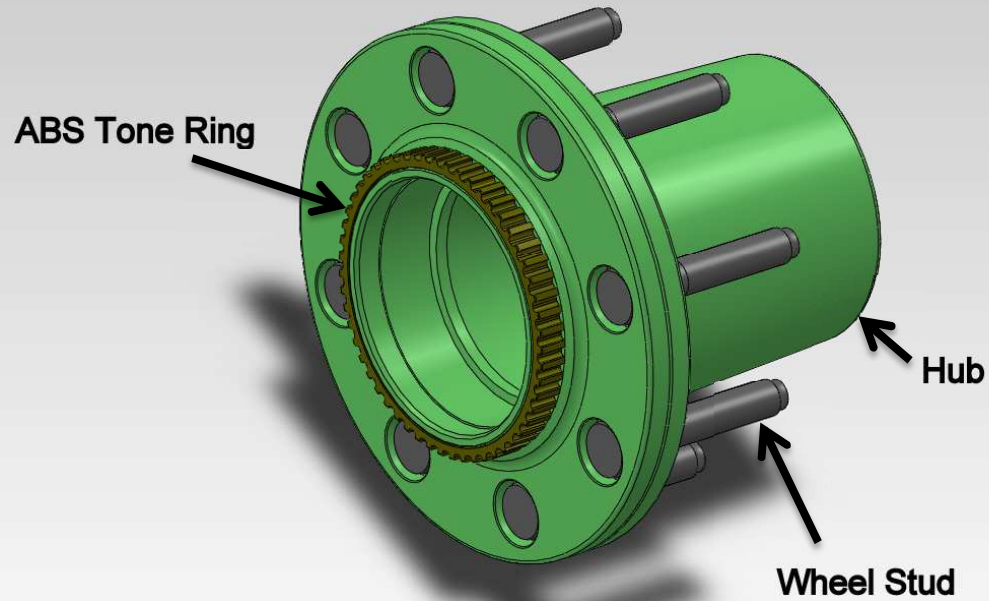
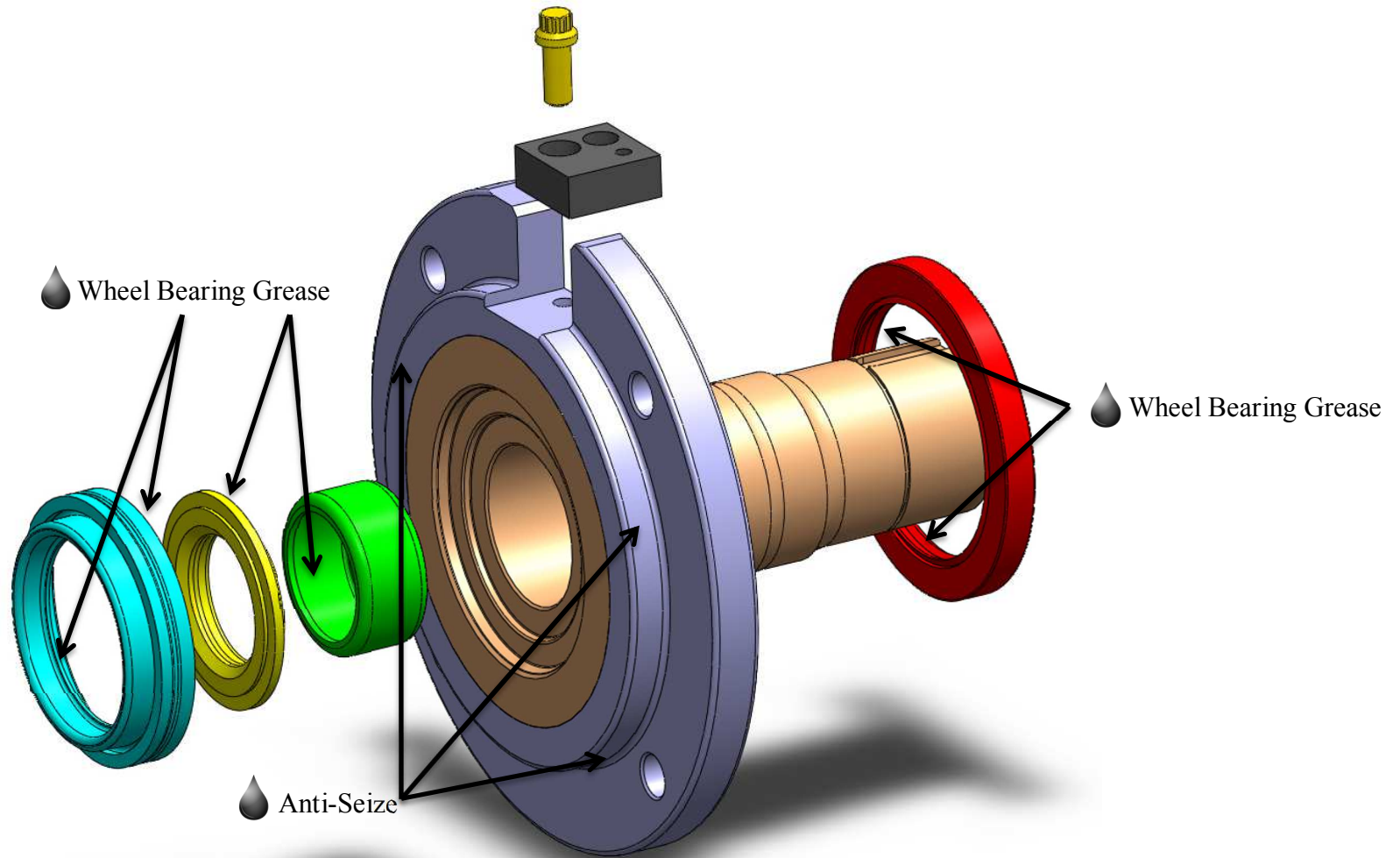

Illustration 3. Lubrication Chart



Torque all Bolts to the following Specs

Fastener	Ft. Lbs.	Nm	Threadlocker
Spindle Mounting Bolts	149	202	Loctite 271
Inner Spindle Nut	50, back off, then hand tight	67	None
Outer Spindle Nut	70	95	None
Caliper Bolts	275	373	Loctite 271
Lug Nuts	140	190	None